

# CONFIGURED DATA SHEET

Upright, Translating

**MODEL:** EMT0005-U001100-0305-EB00-0000



Product Image



Configured Product Image

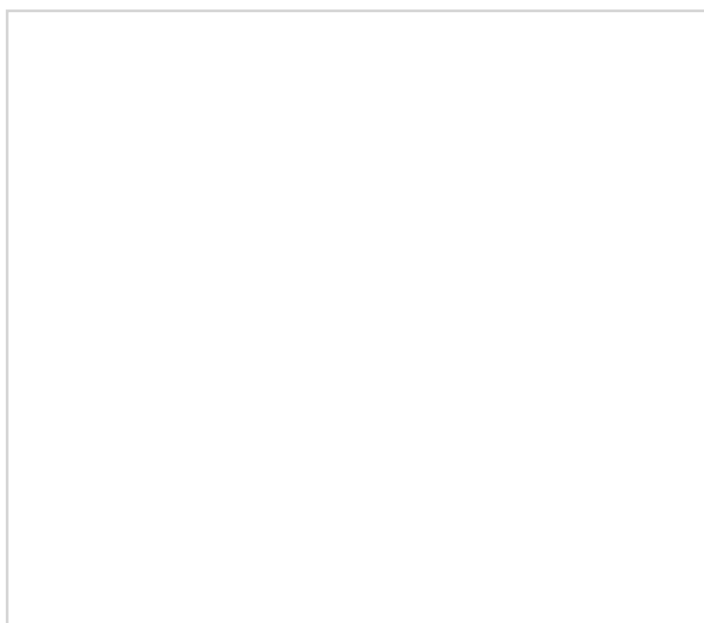

Configured Product - Dynamic 3D Content

[www.powerjacks.com](http://www.powerjacks.com)  
[sales@powerjacks.com](mailto:sales@powerjacks.com)

Tel: +44 (0) 1224 968968

Power Jacks Limited  
Kingshill Commercial Park  
Prospect Road, Westhill  
Aberdeenshire, AB32 6FP  
Scotland (UK)

Registered in Scotland No.103849  
VAT number: GB 470 9558 17



# CONFIGURED DATA SHEET

Upright, Translating

**MODEL:** EMT0005-U001100-0305-EB00-0000

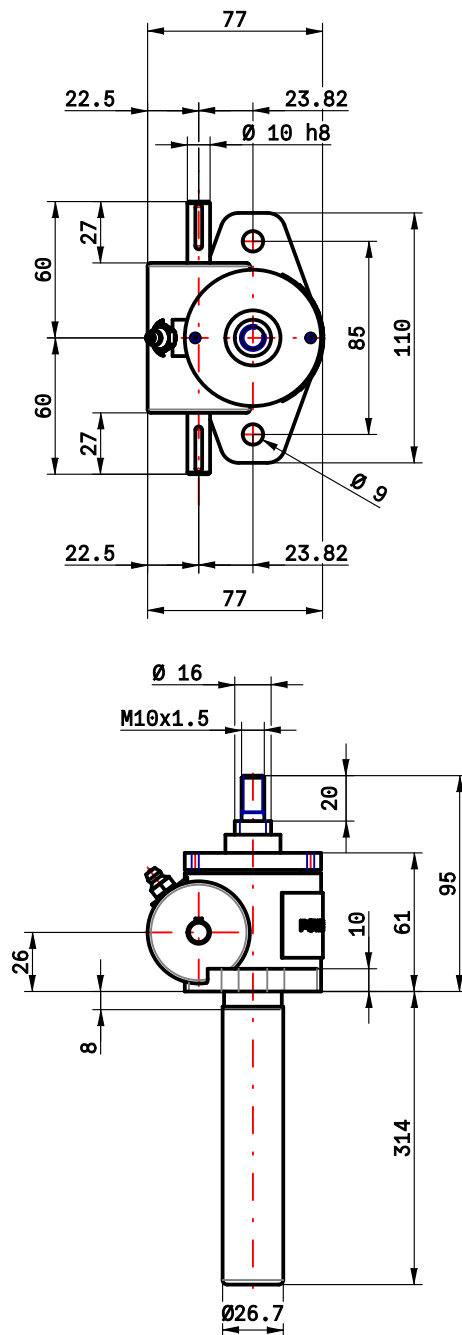

Note: All dimensions in mm unless otherwise stated

[www.powerjacks.com](http://www.powerjacks.com)  
[sales@powerjacks.com](mailto:sales@powerjacks.com)

Tel: +44 (0) 1224 968968

Power Jacks Limited  
Kingshill Commercial Park  
Prospect Road, Westhill  
Aberdeenshire, AB32 6FP  
Scotland (UK)

Registered in Scotland No.103849  
VAT number: GB 470 9558 17



# CONFIGURED DATA SHEET

Upright, Translating

**MODEL:** EMT0005-U001100-0305-EB00-0000

## CONFIGURATION SUMMARY

Product Code	EMT0005-U001100-0305-EB00-0000
Gearbox Feature - 1	None
Gearbox Feature - 2	None
Gear Ratio	5:1
Lifting Screw Lead	Option 1 Lead - Right Hand(Standard)
Worm Shaft Type	Standard Material
Stroke (mm)	305
Worm Shaft Ends	Both
Screw End Fitting	Threaded
Gearbox Mounting	Base Mount
Lifting Screw Material	Standard
Lifting Screw Covers	Cover Pipe and No Bellows Boot
Drive Type	None
Mounting Kit for Limit Switches & Stop Nuts	None
Paint - Lubricant -Seals	Standard Paint, Lubricant and Seals

Note: All rights reserved by Power Jacks Limited. May not be copied in whole or in part.

[www.powerjacks.com](http://www.powerjacks.com)  
[sales@powerjacks.com](mailto:sales@powerjacks.com)

Tel: +44 (0) 1224 968968

Power Jacks Limited  
Kingshill Commercial Park  
Prospect Road, Westhill  
Aberdeenshire, AB32 6FP  
Scotland (UK)

Registered in Scotland No.103849  
VAT number: GB 470 9558 17

